

Serie Actuators

Cilindro a Cartuccia

Cartridge Cylinders
Einschraubzylinder
Vérins cartouche
Cilindros de cartucho
Cilindro Plug

Ø 6-16 mm

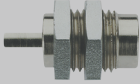

Serie CA - CAF

Pag. 19.5

MiniCilindri

MiniCylinders
Minizylinder
Mini-vérins
Minicilindros
Mini-cilindros

ISO 6432 - Ø 8-25 mm



Serie Mini

Pag. 19.8

MiniCilindri Inox

MiniCylinders Inox
Minizylinder Inox
Mini-vérins inox
Minicilindros Inox
Mini-cilindros Inox

ISO 6432 - Ø 16-25 mm

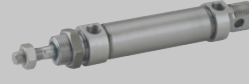

Serie Mini Inox

Pag. 19.21

Cilindro A95

Cilindros A95
Zylinder A95
Vérins A95
Cilindros A95
Cilindros A95

Ø 32-63 mm

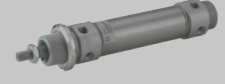

Serie A95

Pag. 19.26

Cilindri Compatti

Compact Cylinder
Kompaktzylinder
Vérins compacts
Cilindros Compactos
Cilindros Compactos

Ø 12-100 mm



Serie Q

Pag. 19.36

Cilindri Corsa Breve

Short Stroke Cylinders
Kurzhubzylinder
Kurzhubzylinder
Vérins à faible course
Cilindros Carrera Corta
Cilindros de curso Reduzido

Ø 12-100 mm

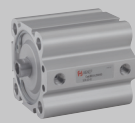

Serie B

Pag. 19.49

Cilindro

Cylinder
Zylinder
Vérins
Cilindros
Cilindros

ISO 15552 - Ø 32-125 mm



Serie L

Pag. 19.65

Cilindro

Cylinder
Zylinder
Vérins
Cilindros
Cilindros

ISO 6431 - Ø 160-320 mm



Serie E

Pag. 19.75

Cilindro

Cylinder
Zylinder
Vérins
Cilindros
Cilindros

ISO 15552 - Ø 32-125 mm

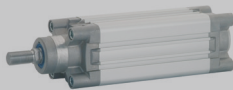

Serie X

Pag. 19.79

Cilindro INOX

Cylinder INOX
Zylinder INOX
Vérins INOX
Cilindros INOX
Cilindros INOX

ISO 15552 - Ø 32-125 mm



Serie V

Pag. 19.87

Cilindro Steli Gemellati

Twin piston rod Cylinders
Twin Kolbenstange Zylinder
Vérins à deux tiges
Cilindros de vástagos gemelos
Cilindro de haste dupla

ISO 15552 - Ø 32-100 mm

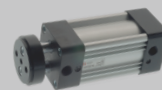

Serie NHA

Pag. 19.92

Cilindri Compatti

Compact Cylinder
Kompaktzylinder
Vérins compacts
Cilindros Compactos
Cilindros Compactos

ISO 21287 - Ø 20-100 mm



Serie W

Pag. 19.99

Cilindri Compatti

Compact Cylinder
Kompaktzylinder
Vérins compacts
Cilindros Compactos
Cilindros Compactos

Ø 125-250 mm



Serie P

Pag. 19.109

Accessori per Cilindri

Accessories for Cylinders
Befestigungselemente für Zylinder
Accessoires pour Vérins
Accesorios para Cilindros
Accesorios para Cilindros

ISO 6431 - ISO 15552 - ISO 21287

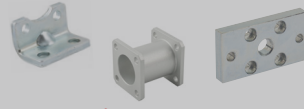

Accessories

Pag. 19.113- 19.126

Unità di Guida

Guide Units
Führungseinheiten
Unités de guidage
Unidades de Guiado
Guia para cilindros

ISO 15552 - Ø 12-25 mm
ISO 6431 VDMA - Ø 32-100 mm



Guide Units

Pag. 19.127

Cilindri con guida integrata

Double-acting magnetic twin-guide cylinders
Zylinder mit integrierter führung
Vérins avec guide intégré
Cilindros con vástagos paralelos
Cilindros com haste dupla

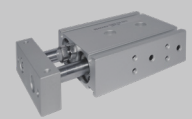

Serie CG01 - CG02

Pag. 19.137

Cilindro con tavola di scorrimento

Slide cylinder
Zylinder mit Schiebetisch
Vérin avec table linéaire
Cilindros guiados con mesa de deslizamiento
Cilindros com mesa deslizante



SHOCK ABSORBER

Serie CG04

Pag. 19.148

Cilindri Senza Stelo

Rodless Cylinder
Kolbenstangenlose Zylinder
Vérins Sans Tige
Cilindro Neumático sin vástago
Cilindro Pneumático sem haste

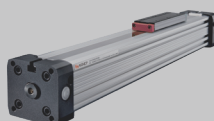

Serie R

Pag. 19.161

Cilindri Rotanti

Rotary cylinders ISO 15552
Drehzylinder ISO 15552
Vérins rotatifs ISO 15552
Cilindros rotativos ISO 15552
Cilindros rotativos ISO 15552

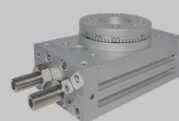

Serie XR - RT01 - RT03S

Pag. 19.180

Pinze pneumatiche

Pneumatic gripper
Pneumatische greifer
Pince pneumatique
Pinza neumática
Garra pneumática



Serie GR01F-GR02F-GR03F GR04F-GR05F

Pag. 19.202

Sensori

Sensor
Sensoren
Capteurs
Sensores
Sensores



DT - DC

Pag. 19.229



DTEX - ATEX

Pag. 19.235



DSL - DSH

Pag. 19.236



Accessories

Pag. 19.239 - 19.240

ATTUATORI PNEUMATICI

PNEUMATIC ACTUATORS

PNEUMATISCHE ANTRIEBE

ACTIONNEURS PNEUMATIQUES

ACTUADORES NEUMÁTICOS

ATUADORES PNEUMÁTICOS



Serie Actuators

Le gamme di attuatori pneumatici Aignep, sono il frutto dell'esperienza produttiva e dei massicci investimenti fatti in ricerca e sviluppo.

Il costante studio delle soluzioni, dei materiali e tecnologie, legate alle esigenze reali e crescenti dei clienti in tutto il mondo consentono ad Aignep di poter offrire soluzioni vincenti ed altamente performanti.

A semplice o doppio effetto, in alluminio o in acciaio inox, nel rispetto di tutte le normative internazionali la gamma proposta consente di affrontare ogni applicazione, dalle più semplici alle più complesse.

Cilindri ATEX:

- **EX** II 2 GD c T6 -20°C<Tamb<80°C

Principali vantaggi

- Conformità alle norme di riferimento internazionali
- Tenute in PU alta scorrevolezza e durata
- 20 tipologie differenti, lineari, senza stelo, guidati
- Versioni alta temperatura e basso attrito
- Differenti materiali costruttivi
- Versioni Custom e speciali
- ATEX di serie
- Disponibilità immediata

Applicazioni

- Automazione Pneumatica, Robotica e manipolazione
- Automotive Process
- Industria tessile, imballaggio, farmaceutica, pesante
- Food Process
- ATEX Zone

Pneumatic actuators is the result of the manufacturing experience of Aignep and major investments toward innovation.

The continuous research for solutions, materials and technologies satisfy the most demanding and specific needs.

Large range of standards: cartridge, compact, mini ISO 6432, ISO 15552, ISO 21287, large bore, rotary etc.

Mainly available in single or double acting, magnetic, cushion, double rods, etc...

Actuators ATEX:

- **EX** II 2 GD c T6 -20°C<Tamb<80°C

Main advantages

- International Standards Conformity
- PU seal low friction and long lasting
- Wide range
- High temperature version on demand
- Wide selection of materials
- Customized or Special version
- ATEX certified
- Immediate delivery

Applications

- Pneumatic Automation, Robotics, Handling
- Automotive Process
- Textile, Packaging, Heavy Duty
- Food Process
- ATEX Zone

Die pneumatischen Antriebe von Aignep sind das Ergebnis grosser Erfahrung in der Herstellung und hohen Investitionen in Forschung und Entwicklung.

Die kontinuierliche Forschung nach Lösungen, Materialien und Technologien bietet Antworten auf die meistgeforderten und spezifischen Bedürfnisse.

Grosse Standard-Auswahl: Patrone, kompakt, Mini ISO 6432, ISO 15552, ISO 21287, grosse Bohrung, Drehbar etc.

Hauptsächlich einfach- oder doppeltwirkend, magnetisch, Dämpfung, durchgehender Kolben, etc ...

Antriebe ATEX:

- **EX** II 2 GD c T6 -20°C<Tamb<80°C

Hauptvorteile

- Konform mit internationalen Standards
- PU-Dichtung glatt und langlebig
- Grosse Auswahl
- Hochtemperaturlösung auf Anfrage
- Grosse Auswahl verschiedener Materialien
- Kunden- oder Sonderausführungen
- ATEX zertifiziert
- Sofortige Lieferung

Anwendungen

- Pneumatische Automation, Robotik, Handling
- Automobil Prozess
- Textil-, Verpackungs-, Schwerlast-Industrie
- Lebensmittel Prozess
- ATEX Bereich

La gamme des vérins pneumatiques est le fruit de l'expérience d'Aignep tant côté fabrication qu'innovation.

Toujours soucieux de développer et d'apporter des solutions pour répondre aux besoins les plus exigeants et spécifiques. Large gamme de produits standards: vérins cartouche, compact, mini suivant ISO 6432, ISO 15552, ISO 21287 etc.

En simple ou double effet, en aluminium ou en acier inoxydable, en conformité avec toutes les normes internationales, permet de faire face à toutes les utilisations, de la plus simple à la plus complexe.

Vérins ATEX:

- **EX** II 2 GD c T6 -20°C<Tamb<80°C

Principaux avantages

- Conformés aux normes internationales
- Joint PU faible friction et longue durée de vie
- Large gamme
- Version haute température sur demande
- Large choix de matériaux
- Versions spéciales sur demande
- Certifié ATEX
- Livraison immédiate

Applications

- Automatisme Pneumatiques, Robotique, Manutention
- Process Automobile
- Textile, Heavy Duty
- Process alimentaire
- Zone ATEX

La gama de actuadores neumáticos Aignep, son el fruto de la experiencia productiva y de las masivas inversiones realizadas en investigación y desarrollo.

El constante estudio de las soluciones, materiales y tecnologías, combinadas con las exigencias reales y crecientes de los clientes de todo el mundo permiten a Aignep de poder ofrecer soluciones ganadoras y de alto rendimiento.

De simple y doble efecto, en aluminio o en acero inox, respetando todas las normativas internacionales la gama propuesta permite afrontar cada aplicación, de las más simples a las más complejas.

Actuadores ATEX:

- **EX** II 2 GD c T6 -20°C<Tamb<80°C

Principales ventajas

- Conformidad a las normas de referencia internacional
- Juntas en PU baja fricción y alta duración
- 20 tipologías diferentes, lineales, sin vástago, guiados
- Versiones para alta temperatura y bajo rozamiento
- Diferentes materiales constructivos
- Versiones Standard y especiales
- ATEX de serie
- Disponibilidad inmediata

Aplicaciones

- Automatización neumática, Robótica y manipulación
- Procesos de automoción
- Industria textil, embalaje, farmacéutica y pesada
- Alimentaria
- Zona ATEX

Os cilindros pneumáticos são o resultado da experiência de produção da Aignep, além de serem seu maior investimento em busca da inovação.

As contínuas pesquisas em soluções, materiais e tecnologias satisfazem as mais severas e específicas necessidades de automação. Um grande range de modelos: cilindros cartucho, compactos, mini ISO 6432, ISO 15552, ISO 21287, large bore, rotativos etc. Principalmente disponíveis em simples ou dupla ação, magnético, com amortecimento pneumático, haste passante, etc...

Cilindros ATEX:

- **EX** II 2 GD c T6 -20°C<Tamb<80°C

Principais vantagens

- Conformidade com Padrões Internacionais
- Alta durabilidade e baixo atrito nas vedações de PU
- Grande range de opções
- Versões para Altas Temperaturas sob demanda
- Grande variação de materiais
- Versões customizadas ou especiais
- Certificação ATEX padrão
- Entrega imediata

Aplicações

- Automação Pneumática, Robótica, Manipulação
- Processos Automotivos
- Têxtil, Embalagem, Heavy Duty
- Processos Alimentícios
- Aprovação ATEX

MINICILINDRI ISO 6432



MINI CYLINDERS ISO 6432
 MINIZYLINDER ISO 6432
 MINI-VÉRINS ISO 6432
 MINI CILINDROS ISO 6432
 CILINDROS MINI ISO 6432



CARATTERISTICHE TECNICHE

TECHNICAL CHARACTERISTICS
 TECHNISCHE ANGABEN
 CARACTÉRISTIQUES TECHNIQUES
 CARACTERÍSTICAS TÉCNICAS
 CARACTERÍSTICAS TÉCNICAS

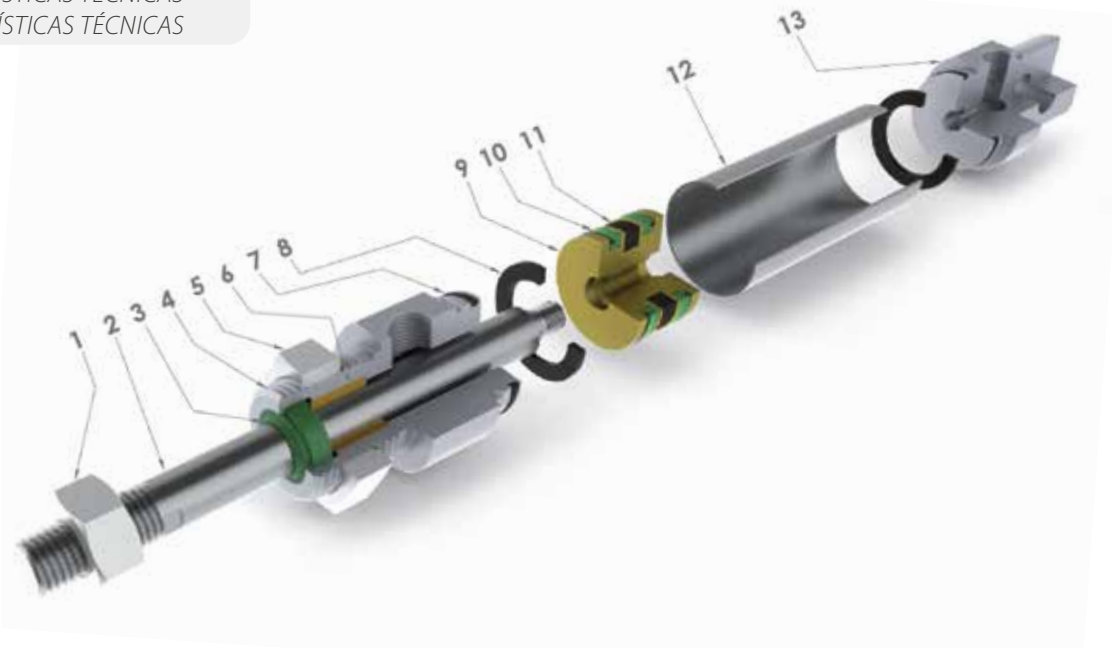

Materiali e Componenti **IT**

- 1 Dado in acciaio zincato
- 2 Asta in acciaio AISI 303
- 3 Guarnizione asta in poliuretano
- 4 Testata anteriore in alluminio anodizzato
- 5 Ghiera in acciaio zincato
- 6 Bronzina in bronzo sinterizzato
- 7 Guarnizioni O-RING in NBR
- 8 Paracolpi in neoprene
- 9 Pistone in ottone
- 10 Guarnizione pistone in poliuretano
- 11 Magnete in plastoferrite
- 12 Camicia minicilindro in acciaio INOX AISI 304
- 13 Testata posteriore in alluminio anodizzato

Component Parts and Materials **GB**

- 1 Zinc-plated steel Nut
- 2 Steel AISI 303 Piston rod
- 3 Polyurethane Rod seal
- 4 Anodised aluminium Front cover
- 5 Zinc-plated steel Nut
- 6 Sintered bronze Bearing
- 7 NBR O-RING Seals
- 8 Neoprene Bumper
- 9 Brass Piston
- 10 Polyurethane Piston seal
- 11 Bonded Ferrite Magnet
- 12 Stainless Steel AISI 304 Mini cylinder shape body
- 13 Anodised aluminium Back cover

Komponenten und Materialien **DE**

- 1 Stahlmutter verzinkt
- 2 Kolbenstange AISI 303
- 3 Kolbenstangendichtung aus Polyurethan
- 4 Zylinderkopf Aluminium eloxiert
- 5 Stahlmutter verzinkt
- 6 Gleitlager Sinterbronze
- 7 O-Ring Dichtung aus NBR
- 8 Dämpfungsring aus Neopren
- 9 Kolben aus Messing
- 10 Kolbendichtung aus Polyurethan
- 11 Magnetring Plastoferrit
- 12 Zylinderrohr AISI 304
- 13 Zylinderdeckel Aluminium eloxiert

Matériaux et Composants **FR**

- 1 Ecrou en acier galvanisé
- 2 Tige de piston en acier inox AISI 303
- 3 Joint de tige en polyuréthane
- 4 Flasque en aluminium anodisé
- 5 Ecrou en acier galvanisé
- 6 Palier en bronze fritté
- 7 Joint torique en NBR
- 8 Amortisseur en néoprène
- 9 Piston en laiton
- 10 Joint de piston en polyuréthane
- 11 Aimant en plastoferrite
- 12 Tube en acier inox AISI 304
- 13 Flasque en aluminium anodisé

Materiales y componentes **ES**

- 1 Tuerca en acero zincado
- 2 Vástago en acero AISI 303
- 3 Junta vástago en poliuretano
- 4 Tapa anterior en aluminio anodizado
- 5 Tuerca en acero zincado
- 6 Cojinete en bronce sinterizado
- 7 Junta tórica en NBR
- 8 Paragolpes en neopreno
- 9 Pistón en latón
- 10 Junta pistón en poliuretano
- 11 Magnete en plastoferrita
- 12 Camisa minicilindro en acero INOX AISI 304
- 13 Tapa posterior en aluminio anodizado

Materiais e Componentes **PT**

- 1 Porca em aço zincado
- 2 Haste em aço AISI 303
- 3 Vedação da haste em poliuretano
- 4 Cabeçote frontal em alumínio anodizado
- 5 Porca em aço zincado
- 6 Bucha do cabeçote em bronze sinterizado
- 7 Vedações O-RING em NBR
- 8 Amortecedor elástico em neoprene
- 9 Êmbolo em latão
- 10 Vedação do êmbolo em poliuretano
- 11 Ímã em plastoferrite
- 12 Camisa do mini-cilindro em aço INOX AISI 304
- 13 Cabeçote traseiro em alumínio anodizado



Norma di Riferimento

Reference standard

Entspricht der Norm

Norme de référence

Normativa de referencia

Norma de referência

1907/2006

REACH ✓

2011/65/CE

RoHS ✓

SILICON
FREE

II 2GD Ex h IIC T6



Pressioni

Pressures

Druckbereich

Pressions

Presiones

Pressões

1 bar (0.1 MPa)

10 bar (1 MPa)



Temperature

Temperatures

Temperatur

Températures

Temperaturas

Temperaturas

0 °C (-20 °C con aria secca)

(-20 °C with dry air)

(-20 °C mit trockener Luft)

(-20 °C avec air sec)

(-20 °C con aire seco)

(-20 °C com ar seco)

+ 80 °C



Fluidi compatibili

Aria compressa filtrata lubrificata e non lubrificata.

Fluids

Filtered and lubricated compressed air as well as non lubricated air.

Geeignete Medien

Filtered and lubricated compressed air as well as non lubricated air.

Fluides compatibles

Air comprimé filtré, lubrifié ou non lubrifié.

Fluidos compatibles

Aire comprimido filtrado lubricado y no lubricado.

Fluidos compatíveis

Ar comprimido filtrado e lubrificado ou não lubrificado.



Funzionamento

Semplice effetto magnetico o non magnetico. Doppio effetto magnetico o non magnetico, stelo singolo o passante, ammortizzato o non ammortizzato.

Functioning

Single acting magnetic or non-magnetic. Double acting single or double end rod, magnetic or non-magnetic, cushioned or non-cushioned.

Funktion

Einfachwirkend magnetisch oder nicht magnetisch. Doppeltwirkend einseitig oder durchgehende Kolbenstange, magnetisch oder nicht magnetisch, gedämpft oder ungedämpft.

Exécutions

Simple effet Magnétique ou non-Magnétique. Double effet Magnétique ou non-Magnétique, tige de piston simple ou traversante, amortisseur ou sans amortisseur.

Funcionamiento

Simple efecto magnético o no magnético. Doble efecto vástago simple o pasante, magnético o no magnético, amortiguado o no amortiguado.

Funcionamento

Simple Ação Magnético ou não-magnético. Dupla ação magnético ou não-magnético, haste simples ou passante, com amortecimento ou sem amortecimento.



Alesaggi

Bores

Durchmesser

Diamètres

Diâmetros

Diâmetros

8 - 10 - 12 - 16 - 20 - 25 mm



Corse Standard

Standard Strokes

Standardhub

Courses standards

Carreras Standard

Cursos Padrão

from 10 to 320 mm



Sensori consigliati

Sensors recommended

Empfohlene Sensoren

Capteurs recommandés

Sensores recomendados

Sensores aconselhados

DSL



Adattatore per sensore

Sensor adapter

Sensor Adapter

Adaptateur pour capteur

Adaptador para sensor

Adaptador para sensor

MFX

FORZE E CONSUMI

FORCES AND CONSUMPTIONS
 KRÄFTE UND LUFTVERBRAUCH
 FORCES ET CONSOMMATIONS D'AIR
 FUERZAS Y CONSUMOS
 FORÇAS E CONSUMOS

Forze di spinta e tiro - Thrust and traction forces - Schub-und zugkräfte - Force de poussée et de traction - Fuerza de empuje y tracción - Força de avanço e recuo.

Cilindro Cylinder Zylinder Vérins Cilindro Cilindro	Stelo Piston rod Stange Tige Vástago Haste	Superficie utile Working Surface Arbeitsfläche Surface de travail Superficie útil Superficie útil	Pressione di lavoro Operating pressure Betriebsdruck Pression de service Presión de trabajo Pressão de operação										
			bar										
∅	∅	mm ²	1	2	3	4	5	6	7	8	9	10	
								Forza sviluppata Output force Zylinderkraft Force du vérin Fuerza desarrollada Força desenvolvida N					
8	4	S = 50,2 T = 37,7	5 3	10 6	15 9	20 12	25 15	30 18	35 21	40 24	45 27	50 30	
10	4	S = 78,5 T = 66	7 6	14 12	21 18	28 24	35 30	42 36	49 42	56 48	63 54	70 60	
12	6	S = 113 T = 85	10 7,5	20 15	30 22	40 30	50 37	60 45	70 52	80 60	90 68	100 75	
16	6	S = 200 T = 173	18 16	36 32	54 48	72 64	90 80	108 96	126 112	144 128	162 144	180 160	
20	8	S = 314 T = 264	28 24	56 48	84 72	112 96	140 120	168 144	196 168	224 192	252 216	280 240	
25	10	S = 490 T = 412	44 36	88 72	132 108	176 144	220 180	264 216	308 252	352 288	396 324	440 360	

S : Spinta
Thrust
Schub
Poussée
Empuje
Avanço

T : Trazione
Traction
Zugkraft
Traction
Tracción
Recuo

Forze della molla - Spring traction forces - Federkraft - Force du ressort - Fuerza del muelle - Força da mola.

Cilindro Cylinder Zylinder Vérins Cilindro Cilindro	Carico molla Load spring Federbelastung Charge du ressort Carga Muelle Força da Mola	Corsa Stroke Hub Course Carrera Curso		
		10	25	50
			Forza sviluppata Output force Zylinderkraft Force du vérin Fuerza desarrollada Força desenvolvida N	
8	R C	4,1 4,5	3,5 4,5	2,6 4,5
10	R C	4,1 4,5	3,5 4,5	2,6 4,5
12	R C	5,5 6	4,8 6	3,5 6
16	R C	16,5 18,3	13,7 18,3	9 18,3
20	R C	19 21,5	15,5 21,5	9,5 21,5
25	R C	27 29	24 29	13,5 29

R : Carico Molla a Riposo
Load of spring at rest
Feder in Ruhstellung
Ressort en position neutre
Carga Muelle en Reposo
Força da Mola em Repouso

C : Carico Molla Compressa
Load of compressed spring
Feder komprimiert
Ressort comprimé
Carga Muelle Comprimido
Força da Mola Comprimida

Consumi cilindro - Cylinder air consumption - Zylinder Luftverbrauch - Consommation d'air des vérins - Consumo cilindro - Consumo de ar do cilindro.

Cilindro Cylinder Zylinder Vérins Cilindro Cilindro	Stelo Rod Stange Tige Vástago Haste	Superficie utile Working Surface Arbeitsfläche Surface de travail Superficie útil Superficie útil	Pressione di lavoro Operating pressure Betriebsdruck Pression de service Presión de trabajo Pressão de operação									
			bar									
∅	∅	mm ²	1	2	3	4	5	6	7	8	9	10
Consumo aria per ogni 10 mm di corsa Air consumption for each 10 mm of stroke Luftverbrauch pro 10 mm Hub Consommation d'air par 10 mm de course Consumo aire para cada 10 mm de carrera Consumo de ar para cada 10 mm de curso NI												
8	4	S = 50,2	0,001	0,002	0,002	0,003	0,003	0,004	0,004	0,005	0,005	0,006
		T = 37,7	0,001	0,001	0,002	0,002	0,002	0,003	0,003	0,003	0,003	0,004
10	4	S = 78,5	0,002	0,002	0,003	0,004	0,005	0,005	0,006	0,007	0,008	0,009
		T = 66	0,001	0,002	0,003	0,003	0,004	0,005	0,005	0,006	0,007	0,007
12	6	S = 113	0,002	0,003	0,005	0,006	0,007	0,008	0,009	0,010	0,011	0,012
		T = 85	0,002	0,003	0,003	0,004	0,005	0,006	0,007	0,008	0,009	0,009
16	6	S = 200	0,004	0,006	0,008	0,010	0,012	0,014	0,016	0,018	0,020	0,022
		T = 173	0,003	0,005	0,007	0,009	0,010	0,012	0,014	0,016	0,017	0,019
20	8	S = 314	0,006	0,009	0,013	0,016	0,019	0,022	0,025	0,028	0,031	0,035
		T = 264	0,005	0,008	0,011	0,013	0,016	0,018	0,021	0,024	0,026	0,029
25	10	S = 490	0,010	0,015	0,020	0,025	0,029	0,034	0,039	0,044	0,049	0,054
		T = 412	0,008	0,012	0,016	0,021	0,025	0,029	0,033	0,037	0,041	0,045

S : Spinta
Thrust
Schub
Poussée
Empuje
Avanço

T : Trazione
Traction
Zugkraft
Traction
Tracción
Recuo



Tabella dei codici di ordinazione

Ordering codes

Bestellschlüssel

Code de commande

Tabla de codificación para pedidos

Tabela de codificação para compra

SERIE	Ø mm	Corsa Stroke Hub Course Carrera Curso mm	Versione speciale Special version Spezial ausführung Version spéciale Versión especial Versão especial
-------	---------	--	---

M F

0 0 8

0 0 2 5

V S

- ▲ **MB** Semplice Effetto Magnetico
Single-Acting Magnetic
Seinfachwirkend Magnetisch
Simple Effet Magnétique
Simple efecto magnético
Simples Ação Magnético
- **MD** Semplice Effetto Magnetico - Molla in Spinta
Single-Acting Magnetic - Spring Thrust
Einfachwirkend Magnetisch
Kolben Ausgefahren
Simple Effet Magnétique - Tige Sortie
Simple Efecto Magnético - Muelle en Empuje
Simples Ação Magnético - Avanço Mola
- **MF** Doppio Effetto Magnetico
Double Acting Magnetic
Doppeltwirkend Magnetisch
Double Effet Magnétique
Doble efecto magnético
Dupla Ação Magnético
- **MFN** Doppio Effetto Magnetico Testata Tronca
Alimentazione 90°
Double Acting Magnetic Head Cut, Feed At 90°
Doppeltwirkend Magnetisch Luftanschluss 90°
Double Effet Magnétique, Alimentation à 90°
Doble efecto magnético tapa plana alimentación 90°
Dupla Ação Magnético Traseira Cortada
Alimentação A 90°
- **MFX** Doppio Effetto Magnetico Testata Tronca
Alimentazione in Asse
Double Acting Magnetic Head Cut
Feed On Axis
Doppeltwirkend Magnetisch Luftanschluss
Stirnseitig
Double Effet Magnétique, Alimentation à l'axe
Doble efecto magnético tapa plana
Alimentación axial
Dupla Ação Magnético Traseira Cortada
Alimentação Axial
- ◆ **MH** Doppio Effetto Ammortizzato Magnetico
Double Acting Cushioned Magnetic
Doppeltwirkend Dämpfung Magnetisch
Double Effet Amortisseurs Magnétique
Doble Efecto Amortiguado Magnético
Dupla Ação Magnético Com Amortecimento
- **MJ** Doppio Effetto Stelo Passante Magnetico
Double Acting Magnetic With Double Rod End
Doppeltwirkend Durchgehender Kolben
Magnetisch
Double Effet Tige Traversante Magnétique
Doble Efecto Vástago pasante Magnético
Dupla Ação Haste Passante Magnético
- ◆ **ML** Doppio Effetto Stelo Passante
Ammortizzato Magnetico
Double Acting Cushioned Magnetic
With Double Rod End
Doppeltwirkend Durchgehender Kolben
Dämpfung Magnetisch
Double Effet Tige Traversante
Amortisseurs Magnétique
Doble Efecto Vástago Pasante
Amortiguado Magnético
Dupla Ação Haste Passante Magnético
Com Amortecimento

008
010
012
016
020
025

0010
0025
0050
0080
0100
0125
0150
0160
0200
0250
0320

- VS Guarnizioni Stelo in FKM
Rod Seals in FKM
Kolbenstangendichtung aus FKM
Joint de tige en FKM
Junta Vástago en FKM
Vedação Haste em FKM
- V Guarnizioni in FKM
Seals in FKM
Dichtungen aus FKM
Joints en FKM
Junta en FKM
Vedação em FKM

A richiesta corse intermedie o superiori.
Intermediate or higher strokes are available upon request.
Auf Anfrage Zwischenhübe.
Autres courses sur demande.
Bajo demanda carreras intermedias o superiores.
Cursos intermediários ou superiores sob encomenda.

Ø mm	Corse - Strokes - Hub - Courses - Carreras - Cursos mm									
	10	25	50	80	100	125	160	200	250	320
8	▲●	▲●	▲●	●	●	●				
10	▲●	▲●	▲●	●	●	●				
12	▲●	▲●	▲●	●	●	●	●	●	●	
16	▲■○	▲■◆○	▲■◆○	◆○	◆○	◆○	◆○	◆○	◆○	◆○
20	▲■○	▲■◆○	▲■◆○	◆○	◆○	◆○	◆○	◆○	◆○	◆○
25	▲■○	▲■◆○	▲■◆○	◆○	◆○	◆○	◆○	◆○	◆○	◆○

MB

SEMPLICE EFFETTO MAGNETICO

SINGLE-ACTING MAGNETIC
 EINFACHWIRKEND MAGNETISCH
 SIMPLE EFFET MAGNÉTIQUE
 SIMPLE EFECTO MAGNÉTICO
 SIMPLIS AÇÃO MAGNÉTICO

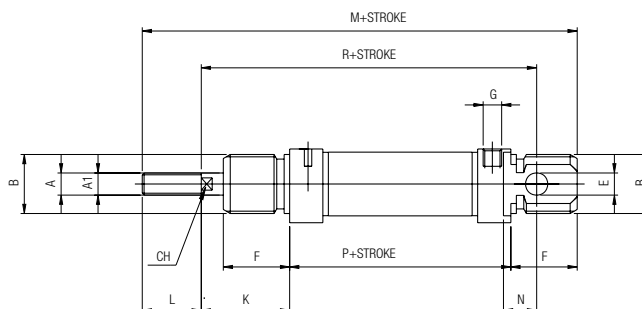
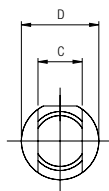
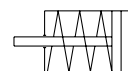

Ø	A	A'	B	C	D	E	F	G	K	L	M	N	P	R	CH
8	M4	4	M12x1.25	8	16	4	12	M5	16	12	86	6	46	64	-
10	M4	4	M12x1.25	8	16	4	12	M5	16	12	86	6	46	64	-
12	M6	6	M16x1.5	12	19	6	18	M5	22	16	104	9	48	75	5
16	M6	6	M16x1.5	12	19	6	18	M5	22	16	109	9	53	82	5
20	M8	8	M22x1.5	16	27	8	20	1/8G	24	20	131	12	67	95	7
25	M10x1.25	10	M22x1.5	16	30	8	22	1/8G	28	22	140	12	68	104	9

MD

SEMPLICE EFFETTO MAGNETICO - MOLLA IN SPINTA

SINGLE-ACTING MAGNETIC - SPRING THRUST
 EINFACHWIRKEND MAGNETISCH - KOLBEN AUSGEFAHREN
 SIMPLE EFFET MAGNÉTIQUE - TIGE SORTIE
 SIMPLE EFECTO MAGNÉTICO - MUELLE EN EMPUJE
 SIMPLIS AÇÃO MAGNÉTICO - AVANÇO MOLLA

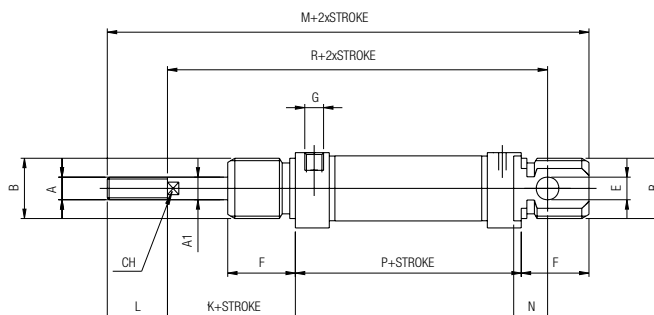
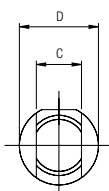
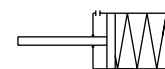

Ø	A	A'	B	C	D	E	F	G	K	L	M	N	P	R	CH
16	M6	6	M16x1.5	12	19	6	18	M5	22	16	134,5	9	78,5	107,5	5
20	M8	8	M22x1.5	16	27	8	20	1/8G	24	20	154	12	90	118	7
25	M10x1.25	10	M22x1.5	16	30	8	22	1/8G	28	22	166	12	94	130	9

MF

DOPPIO EFFETTO MAGNETICO

DOUBLE ACTING MAGNETIC
 DOPPELTWIRKEND MAGNETISCH
 DOUBLE EFFET MAGNÉTIQUE
 DOBLE EFECTO MAGNÉTICO
 DUPLA AÇÃO MAGNÉTICO

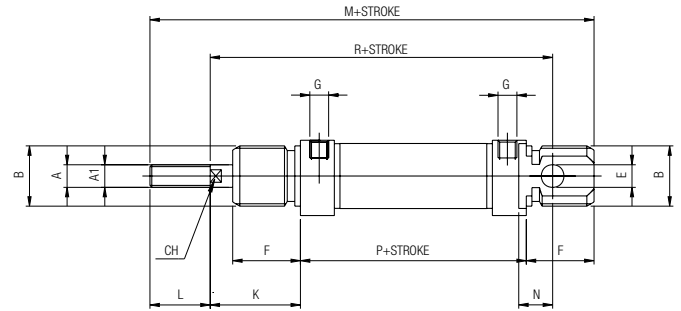
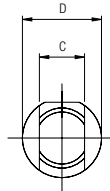
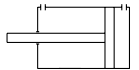

Ø	A	A1	B	C	D	E	F	G	K	L	M	N	P	R	CH
8	M4	4	M12x1.25	8	16	4	12	M5	16	12	86	6	46	64	-
10	M4	4	M12x1.25	8	16	4	12	M5	16	12	86	6	46	64	-
12	M6	6	M16x1.5	12	19	6	18	M5	22	16	104	9	48	75	5
16	M6	6	M16x1.5	12	19	6	18	M5	22	16	109	9	53	82	5
20	M8	8	M22x1.5	16	27	8	20	1/8G	24	20	131	12	67	95	7
25	M10x1.25	10	M22x1.5	16	30	8	22	1/8G	28	22	140	12	68	104	9

MFN

DOPPIO EFFETTO MAGNETICO TESTATA TRONCA ALIMENTAZIONE 90°

DOUBLE ACTING MAGNETIC HEAD CUT, FEED AT 90°
 DOPPELTWIRKEND MAGNETISCH LUFTANSCHLUSS 90°
 DOUBLE EFFET MAGNÉTIQUE ALIMENTATION À 90°
 DOBLE EFECTO MAGNÉTICO TAPA PLANA ALIMENTACIÓN 90°
 DUPLA AÇÃO MAGNÉTICO TRASEIRA CORTADA ALIMENTAÇÃO A 90°

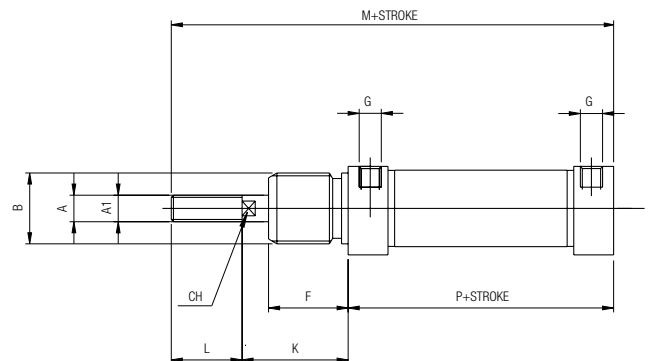
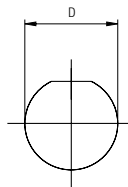
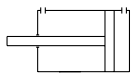

Ø	A	A'	B	D	G	K	L	M	P	CH	F
16	M6	6	M16x1.5	21	M5	22	16	91.5	53	5	18
20	M8	8	M22x1.5	27	1/8G	24	20	111.5	67	7	2
25	M10x1.25	10	M22x1.5	30	1/8G	28	22	118.5	68	9	22

MFX

DOPPIO EFFETTO MAGNETICO TESTATA TRONCA ALIMENTAZIONE IN ASSE

DOUBLE ACTING MAGNETIC HEAD CUT FEED ON AXIS
 DOPPELTWIRKEND MAGNETISCH LUFTANSCHLUSS STIRNSEITIG
 DOUBLE EFFET MAGNÉTIQUE /ALIMENTATION À L'AXE
 DOBLE EFECTO MAGNÉTICO TAPA PLANA ALIMENTACIÓN AXIAL
 DUPLA AÇÃO MAGNÉTICO TRASEIRA CORTADA ALIMENTAÇÃO AXIAL

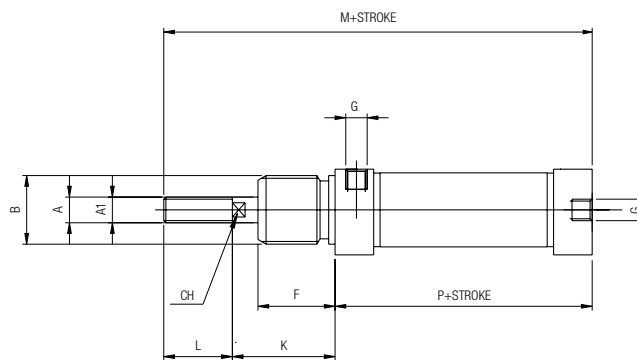
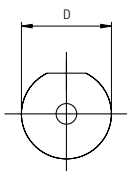
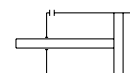

Ø	A	A1	B	D	G	K	L	M	P	CH	F
16	M6	6	M16x1.5	21	M5	22	16	91.5	53	5	18
20	M8	8	M22x1.5	27	1/8G	24	20	111.5	67	7	2
25	M10x1.25	10	M22x1.5	30	1/8G	28	22	118.5	68	9	22

MH

DOPPIO EFFETTO AMMORTIZZATO MAGNETICO

DOUBLE ACTING CUSHIONED MAGNETIC
 DOPPELTWIRKEND DÄMPFUNG MAGNETISCH
 DOUBLE EFFET AMORTISSEURS MAGNÉTIQUE
 DOBLE EFECTO AMORTIGUADO MAGNÉTICO
 DUPLA AÇÃO MAGNÉTICO COM AMORTECIMENTO

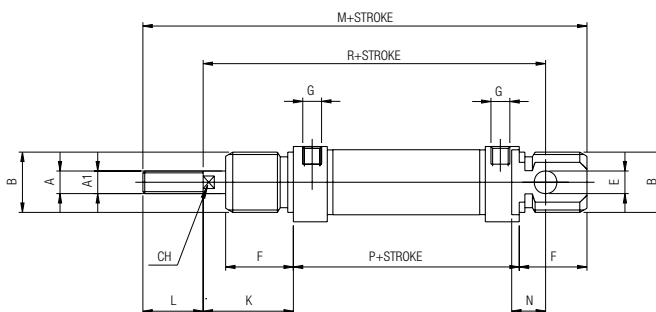
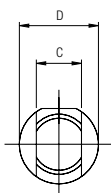
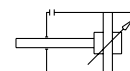

Ø	A	A1	B	C	D	E	F	G	K	L	M	N	P	R	CH
16	M6	6	M16x1.5	12	21	6	18	M5	22	16	109	9	53	82	25
20	M8	8	M22x1.5	16	27	8	20	1/8G	24	20	131	12	67	95	7
25	M10x1.25	10	M22x1.5	16	30	8	22	1/8G	28	22	140	12	68	104	9

MJ

DOPPIO EFFETTO STELO PASSANTE MAGNETICO

DOUBLE ACTING MAGNETIC WITH DOUBLE ROD END
 DOPPELTWIRKEND DURCHGEHENDER KOLBEN MAGNETISCH
 DOUBLE EFFET TIGE TRAVERSANTE MAGNÉTIQUE
 DOBLE EFECTO VÁSTAGO PASANTE MAGNÉTICO
 DUPLA AÇÃO HASTE PASSANTE MAGNÉTICO

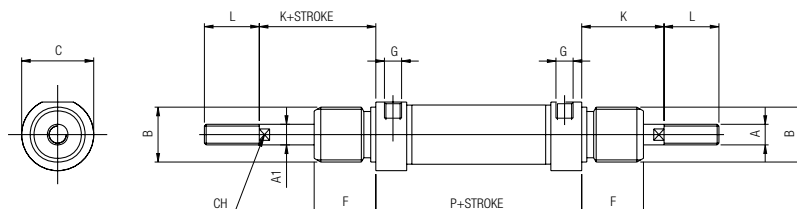
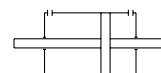

Ø	A	A'	B	C	F	G	K	L	P	CH
16	M6	6	M16x1.5	19	18	M5	22	16	53	5
20	M8	8	M22x1.5	27	20	1/8G	24	20	67	7
25	M10x1.25	10	M22x1.5	30	22	1/8G	28	22	68	9

ML

DOPPIO EFFETTO STELO PASSANTE AMMORTIZZATO MAGNETICO

DOUBLE ACTING CUSHIONED MAGNETIC WITH DOUBLE ROD END
 DOPPELTWIRKEND DURCHGEHENDER KOLBEN DÄMPFUNG MAGNETISCH
 DOUBLE EFFET TIGE TRAVERSANTE AMORTISSEURS MAGNÉTIQUE
 DOBLE EFECTO VÁSTAGO PASANTE AMORTIGUADO MAGNÉTICO
 DUPLA AÇÃO HASTE PASSANTE MAGNÉTICO COM AMORTECIMENTO

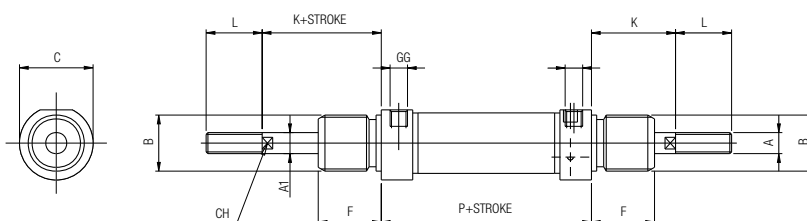
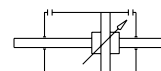

Ø	A	A'	B	C	F	G	K	L	P	CH
16	M6	6	M16x1.5	21	18	M5	22	16	53	5
20	M8	8	M22x1.5	27	20	1/8G	24	20	67	7
25	M10x1.25	10	M22x1.5	30	22	1/8G	28	22	68	9

BLOCCATELO PER CILINDRI ISO 6432

PISTON ROD LOCK FOR CYLINDERS ISO 6432
 FESTELLEINHEIT FÜR ZYLINDER ISO 6432
 UNITÉ DE VERROUILLAGE POUR VÉRINS ISO 6432
 UNIDADES DE BLOQUEO PARA CILINDROS ISO 6432
 FREIO DE HASTE PARA CILINDROS ISO 6432



CARATTERISTICHE TECNICHE

TECHNICAL CHARACTERISTICS
 TECHNISCHE ANGABEN
 CARACTÉRISTIQUES TECHNIQUES
 CARACTERÍSTICAS TÉCNICAS
 CARACTERÍSTICAS TÉCNICAS



1907/2006

REACH ✓

2011/65/CE

RoHS ✓

 SILICON
 FREE

Temperature

Temperatures

Temperatur

Températures

Temperaturas

Temperaturas

0 °C (-20 °C con aria secca)

(-20 °C with dry air)

(-20 °C mit trockener Luft)

(-20 °C avec air sec)

(-20 °C con aire seco)

(-20 °C com ar seco)

+ 80 °C

Pressioni

Pressures

Druckbereich

Pressions

Presiones

Pressões

In assenza di pressione: BLOCCATO

Without Pressures: LOCKED

Im drucklosen Zustand: BLOCKIERT

Position en l'absence de pression: BLOQUÉ

En ausencia de Presión: BLOQUEADO

Na ausência de Pressão: TRAVADO

Pressione Cilindro
 Cylinder Supply Pressure
 Zylinderdruck
 Pression de Vérin
 Presión cilindro
 Pressão do cilindro

Pressione minima di sbloccaggio
 Minimum release pressure
 Minimale Lösedruck
 Pression de déblocage
 Presión mínima de desbloqueo
 Pressão mínima de desbloqueio

0 ÷ 7 bar (0 ÷ 0.7 Mpa)

2.5 bar (0.25 Mpa)

7 ÷ 10 bar (0.7 ÷ 1 Mpa)

3 bar (0.3 Mpa)

Fluidi compatibili

 Aria compressa filtrata lubrificata
 e non lubrificata.

Fluids

 Filtered and lubricated compressed air
 as well as non lubricated air.

Geeignete Medien

 Filtered and lubricated compressed air
 as well as non lubricated air.

Fluides compatibles

Air comprimé filtré, lubrifié ou non lubrifié.

Fluidos compatibles

 Aire comprimido filtrado lubricado
 y no lubricado.

Fluidos compatíveis

 Ar comprimido filtrado e lubrificado
 ou não lubrificado.

Come Ordinare

IT

Il bloccateLO può essere assemblato solo su cilindri ISO 6432 Ø 20 o 25 mm con stelo prolungato.

Per identificare il cilindro con stelo prolungato e bloccateLO assemblato è necessario indicare dopo il codice del cilindro la lettera "B".

How to Order

GB

The piston rod lock can be assembled only with cylinders ISO 6432 Ø 20 or 25 mm produced with an extended piston rod.

To identify the cylinder with extended piston rod and piston rod lock assembled, it is necessary to mention after the article code of the cylinder the letter "B".

Wie Bestellen

DE

Die Feststelleinheit kann nur mit den ISO 6432 Zylinder Ø 20 bis 25 mm mit verlängerter Kolbenstange zusammengesetzt werden. Zur Identifizierung der Zylinderbaugruppe mit verlängerter Kolbenstange und Feststelleinheit, ist es notwendig nach dem Abschnitt Zylinder Nummer den Buchstaben "B" zu erwähnen.

Comment Commander

FR

L'unité de verrouillage ne peut être assemblée qu'avec les vérins ISO 6432 Ø 20 mm et 25 mm produits avec une tige prolongée.

Pour identifier les vérins avec une tige de piston prolongée et un verrouillage de tige assemblé, il est nécessaire de mentionner après le type du vérin la lettre "B".

Como Hacer un Pedido

ES

La unidad de bloqueo puede ser montada sólo sobre cilindro ISO 6432 Ø 20 o 25 mm con el vástago prolongado.

Para identificar el cilindro con el vástago prolongado y unidad de bloqueo montado, es necesario añadir al código del cilindro la letra "B".

Como Pedir

PT

O freio pode ser montado somente nos cilindros ISO 6432 Ø 20 o 25 mm com haste prolongada.

Para adquirir o cilindro com haste prolongada e freio é necessário indicar depois do código do cilindro a letra "B".



Tabella dei codici di ordinazione

Ordering codes

Bestellschlüssel

Code de commande

Tabla de codificación para pedidos

Tabela de codificação para compra

Codice Cilindri Cylinders Code Zylinder Nummer Code Du Vérin Código cilindro Código Cilindro	Esecuzione Execution Ausführung Exécutions Ejecución Execução	Ø mm	Corsa Stroke Hub Course Carrera Curso mm
---	--	---------	--

M F

B

0 2 0

0 0 2 5

B Bloccastelo Assemblato
Piston Rod Lock Assembled
Feststleinheit Montiert
Verrouillage Assemblé
Unidad de bloqueo Montada
Freio Montado

020
025

0010
0025
0050
0080
0100
0125
0150
0160
0200
0250
0320

A richiesta corse intermedie o superiori.

Intermediate or higher strokes are available upon request.

Auf Anfrage Zwischenhübe.

Autres courses sur demande.

Bajo demanda carreras intermedias o superiores.

Cursos intermedios ou superiores sob encomenda.

MRL

BLOCCASTELO

PISTON ROD LOCK

FESTELLEINHEIT

UNITÉ DE VERROUILLAGE

UNIDAD DE BLOQUEO

FREIO PARA HASTE

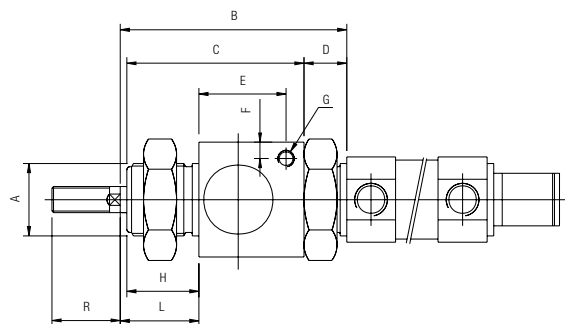
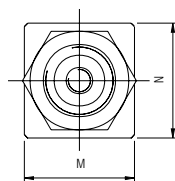

Code	Ø	A	B	C	D	E	F	G	H	L	M	N	R
MRL 020	20	M22x1.5	68.5	54	13	27	5	M5	22	23.5	34	35	23
MRL 025	25	M22x1.5	69.5	54	13	27	5	M5	22	24.5	34	35	26

MFL

FLANGIA

FLANGE
FLANSCH
BRIDE
BRIDA
FLANGE

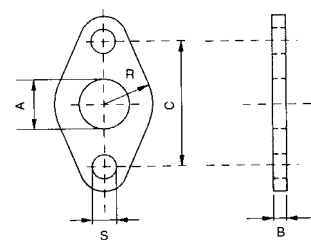

Code	Ø	A	B	C	R	S
MFL 008	8-10	12	3	30	9	4.5
MFL 012	12-16	16	4	40	13	5.5
MFL 020	20-25	22	5	50	19	6.6

MATERIALE: Acciaio - MATERIAL: Steel - MATERIAL: Stahl - MATÉRIEL: Acier - MATERIAL: Acero - MATERIAL: Aço

MPD

PIEDINO

FOOT
FUSSBEFESTIGUNG
EQUERRE DE FIXATION
PATA
PÉS

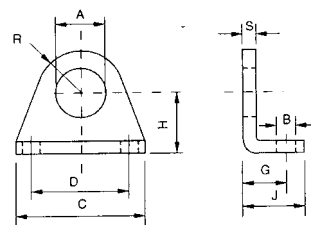

Code	Ø	A	B	C	D	G	H	J	R	S
MPD 008	8-10	12	4.5	35	25	11	16	16	10	3
MPD 012	12-16	16	5.5	42	32	14	20	20	13.5	4
MPD 020	20-25	22	6.6	54	40	17	25	25	18	5

MATERIALE: Acciaio - MATERIAL: Steel - MATERIAL: Stahl - MATÉRIEL: Acier - MATERIAL: Acero - MATERIAL: Aço

MCC

CERNIERA

CLEVIS BRACKET
GABELBEFESTIGUNG
CHAPE DE FIXATION
CHARNELA
OSCILANTE

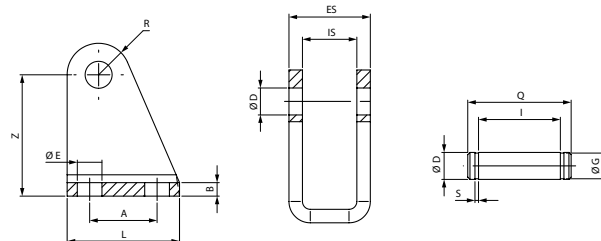

Code	Ø	A	B	R	L	Z	IS	ES	S	I	Q	ØE	ØD	ØG
MCC 008	8-10	12.5	2.5	5	22	24	8.1	13	0.8	14	18	4.5	4	2.3
MCC 012	12-16	15	3	7	25	27	12	18	0.8	19	24	5.5	6	4
MCC 020	20-25	20	4	10	32	30	16	24	0.9	25	30	6.5	8	7

MATERIALE: Acciaio - MATERIAL: Steel - MATERIAL: Stahl - MATÉRIEL: Acier - MATERIAL: Acero - MATERIAL: Aço

DA

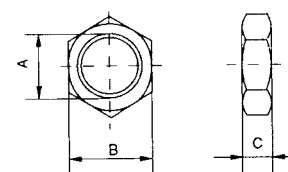

DADO PER TESTATE

NUT FOR COVERS
MUTTER FÜR ZYLINDERBEFESTIGUNG
ÉCROU DE FIXATION DU VÉRIN
TUERCA PARA TAPAS
PORCA PARA CABEÇOTE

Code	A	B	C
ODA00 00 51 D5 ZI	M12x1.25	19	7
ODA00 00 51 E3 ZI	M16x1.5	22	6
ODA00 00 51 F6 ZI	M22x1.5	27	8

DADO PER STELI

NUT FOR RODS
MUTTER FÜR KOLBENSTANGE
ÉCROU POUR TIGE DE PISTON
TUERCA PARA VÁSTAGO
PORCA PARA HASTE

Code	A	B	C
ODA00 00 51 B1 ZI	M4	7	3.2
ODA00 00 51 B8 ZI	M6	10	5
ODA00 00 51 C3 ZI	M8x1.25	13	6.5
ODA00 00 51 C9 ZI	M10x1.25	17	8

MATERIALE: Acciaio - MATERIAL: Steel - MATERIAL: Stahl - MATÉRIEL: Acier - MATERIAL: Acero - MATERIAL: Aço

FC

FORCELLA CON CLIPS

YOKE WITH LOCABLE PIN
GABELKOPF MIT SICHERUNGSClip
CHAPE DE TIGE AVEC CLIP DE SÉCURITÉ
HORQUILLA CON CLIPS
GARFO COM CLIPS

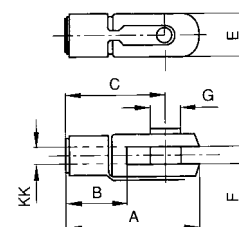

Code	KK	A	B	C	E	F	G
FC 008	M4	21	8	16	8	4	4
FC 012	M6	31	12	24	12	6	6
FC 020	M8	42	16	32	16	8	8
FC 025	M10x1.25	52	20	40	20	10	10

MATERIALE: Acciaio - MATERIAL: Steel - MATERIAL: Stahl - MATÉRIEL: Acier - MATERIAL: Acero - MATERIAL: Aço

TF

TESTE DI BIELLA AUTOLUBRIFICANTI

ROD ENDS SELF-LUBRICATING
GELENKKOPF SELBSTSCHMIEREND
OUILLETON À ROTULE AUTOLUBRIFIANT
RÓTULA AUTOLUBRICANTE
RÓTULA ESFERA AUTO-LUBRIFICANTE

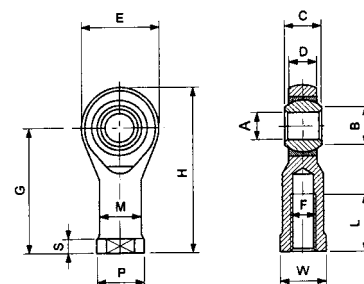

Code	F	A	B	C	Ø Sfera Sphere Kugel Sphère Esfera	D	E	G	H	L	M	P	S	W	Carico radiale Radial load Radiallast Charge radiale Carga radial Carga radial		Peso Weight Gewicht Poids Peso Peso
		H7	0	0 -0.13		±0.13	±0.5	±0.5		±0.7	±0.7	±0.5	+0.2 -0.7	±0.25	D	S	g
TF 008	M4x0,7	5	7,7	8	11,11	6	18	27	36	10	9	11	4	9	-	-	-
TF 012	M6x1	6	8,9	9	12,7	6,75	20	30	40	9	10	13	5	11	470	1.100	19
TF 020	M8x1.25	8	10,4	12	15,88	9	24	36	48	12	12,5	16	5	14	780	1.900	36
TF 025	M10x1,25	10	12,9	14	19,05	10,5	28	43	57	15	15	19	6,5	17	1.200	3.100	88

MATERIALE: Acciaio - MATERIAL: Steel - MATERIAL: Stahl - MATÉRIEL: Acier - MATERIAL: Acero - MATERIAL: Aço

D : Dinamico
Dynamic
Dinamisch
Dynamique
Dinámica
Dinámico

S : Statico
Static
Statis
Statique
Estática
Estático